

# MODEL SH-002 INSTALLATION DETAILS

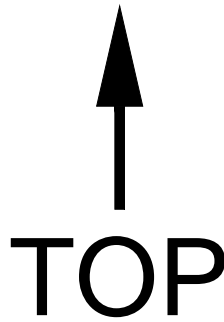

## SURFACE INSTALLATION

FOR SURFACE INSTALLATION, USE THE TOP OF THE BACKBOX TO LEVEL IT. THE BOX MUST BE INSTALLED LEVEL AND PLUMB.

## FLUSH INSTALLATION

FOR FLUSH INSTALLATION, ENCLOSURE MUST BE MOUNTED FLUSH WITH THE WALL, OR WITH THE USE OF THE ADJUSTABLE FLUSH TRIM RING, THE ENCLOSURE MAY PROTRUDE FROM THE WALL. THE ENCLOSURE SHOULD UNDER NO CIRCUMSTANCES BE MOUNTED DEEPER THAN FLUSH WITH THE FINISHED WALL.

## DOOR INSTALLATION

THE DOOR THAT MOUNTS TO THE FRONT OF THE ENCLOSURE IS 3/4" THICK.

## OPTIONAL FLUSH TRIM

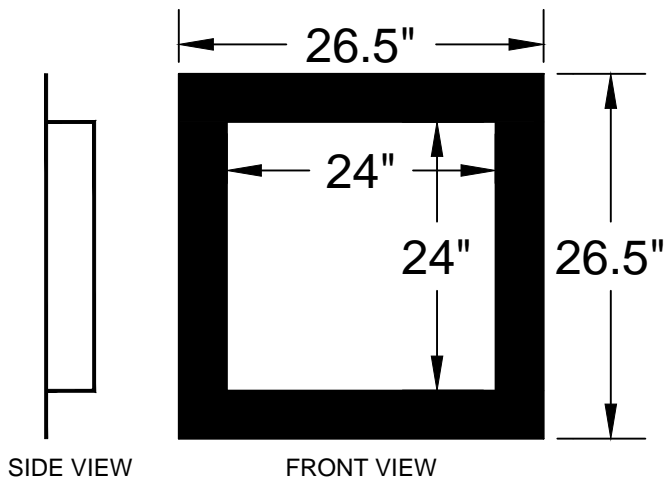

## BACKBOX DIMENSIONS

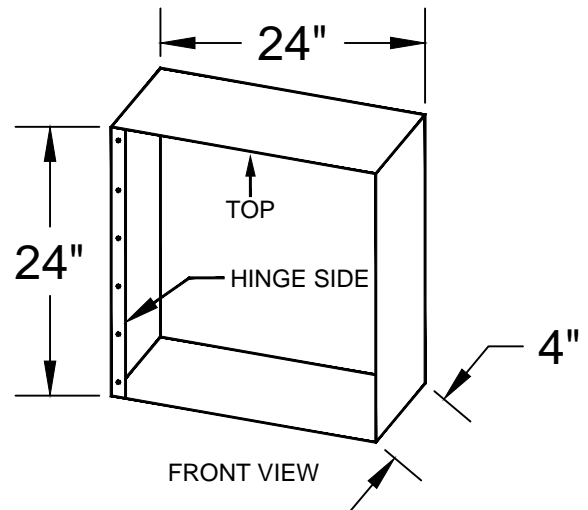

\* DO NOT INSTALL CONDUIT FROM THE BACK UNLESS YOU NOTIFY GEMCOM AND GET APPROVAL ON A LOCATION.

\* ENCLOSURE TO BE MOUNTED WITH HINGE ON THE LEFT.